

# CRUISE N COMFORT USA

No Idle Solution For Trucks



Since 2010 Cruise N Comfort USA has been producing cooling solutions for heavy equipment and trucks. The 2 systems we offer are the HD Series that is a 2 component system and the VES Classic that has 3 major components



MODEL	HD series
OPERATING VOLTAGE	12L- 10-15 VDC 24L- 20-31 VDC 48L- 40-62 VDC
CURRENT CONSUMPTION	12L- 38-49 AMPS * 24L- 20-33 AMPS* 48L- 8-16 AMPS*
COOLING CAPACITY	12L- 9,500 BTU 24L-11,000 BTU 48L-12,000 BTU
FEATURES	
THERMOSTAT COMPATABLE	OPTIONAL, unit comes with on/off switch and variable blower speed
ECO MODE	YES <b>ECO</b> CRUISE
REFRIGERANT	R134a requires charging
Refrigerant Hoses included	Yes ( 7 feet with ends crimped on)

MODEL	VES CLASSIC
OPERATING VOLTAGE	12L- 10-15 VDC 24L- 20-31 VDC
CURRENT CONSUMPTION	12L- 43-52 AMPS* 24L- 20-33 AMPS*
COOLING CAPACITY	12L- 8,500 BTU 24L- 10,000 BTU
FEATURES	
THERMOSTAT COMPATABLE	No, unit has 3 position switch for on/off blower speed
ECO MODE	NO <b>MAX COOL ONLY</b>
REFRIGERANT	R134a requires charging
Refrigerant Hoses included	No

## CRUISE N COMFORT USA

1020 West Ranch Road Suite 102 Tempe, AZ 85284

Tel: 1(855)899-1442 Fax: 1(888)246-2832

Email: info@CruiseNComfortUSA

# Typical Semi Truck Installation HD-12L

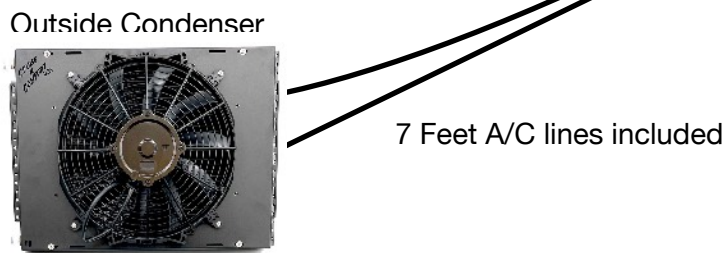
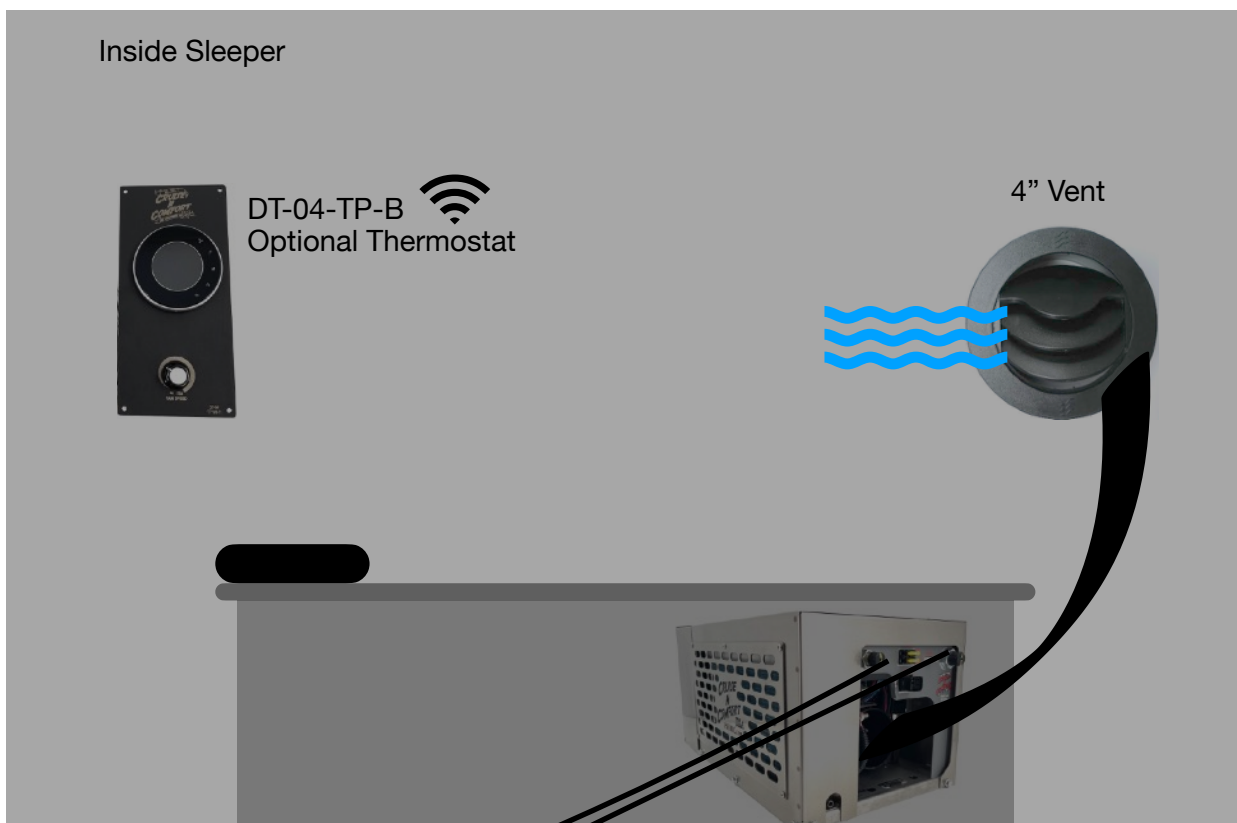

## Powering Unit

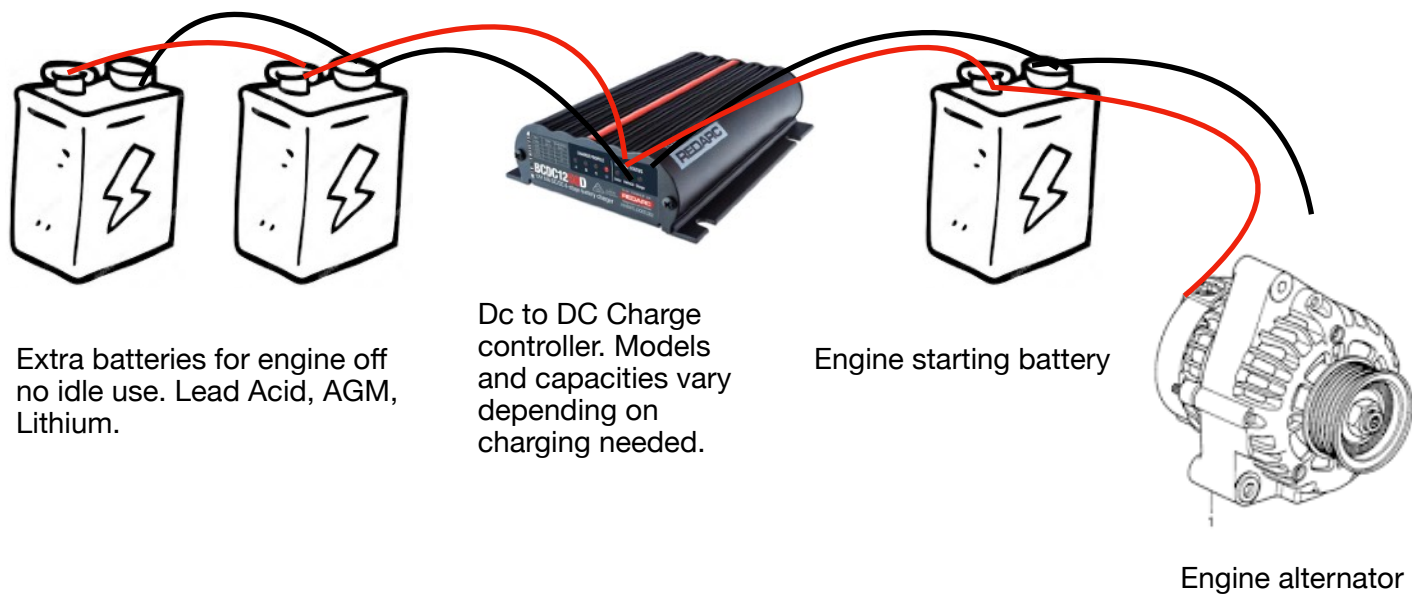

Typical Semi Truck Installation  
VES

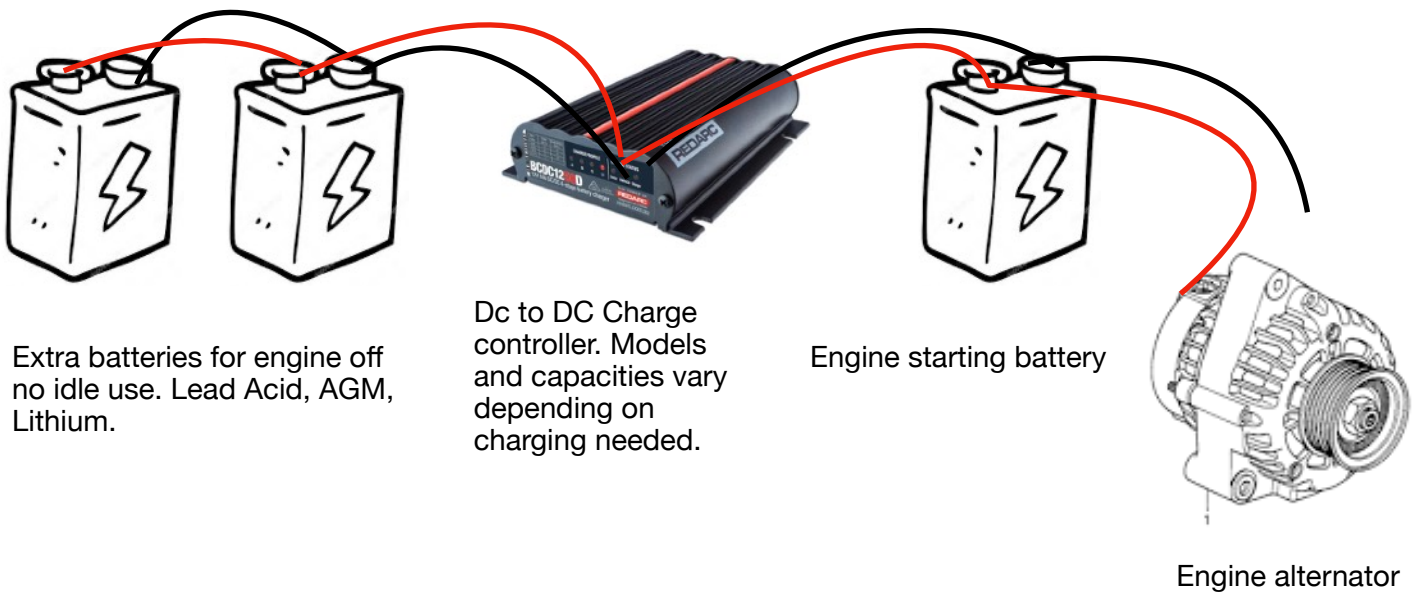
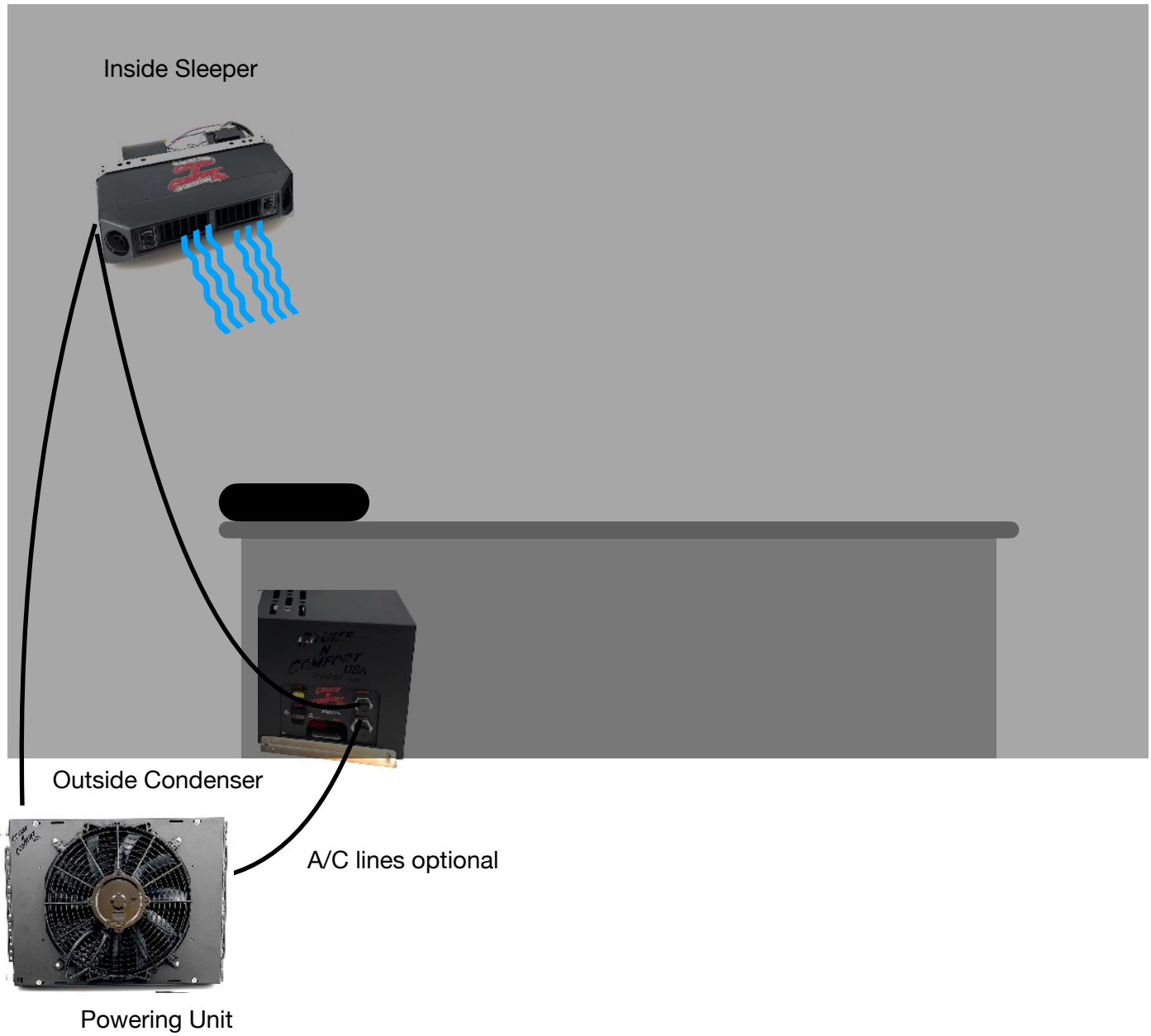

# Single Fan Condenser

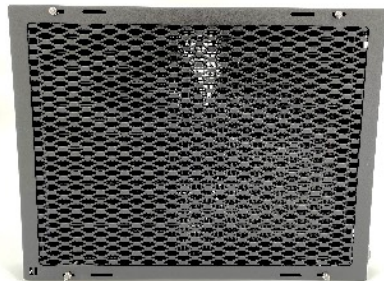

Optional Rock Guard

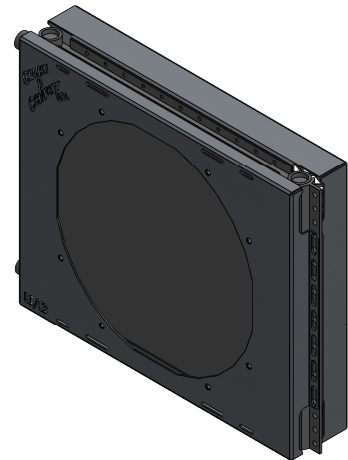
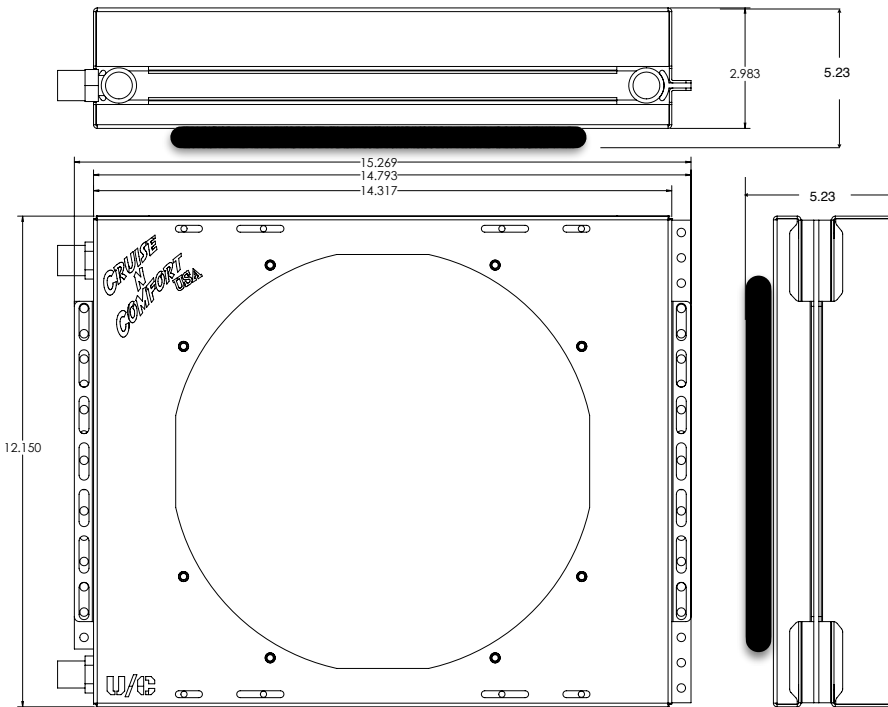

WEIGHT:  
SINGLE FAN CONDENSER 7.8LBS.  
SINGLE FAN ROCK GUARD 1.6 LBS.

# Optional Dual Fan Condenser

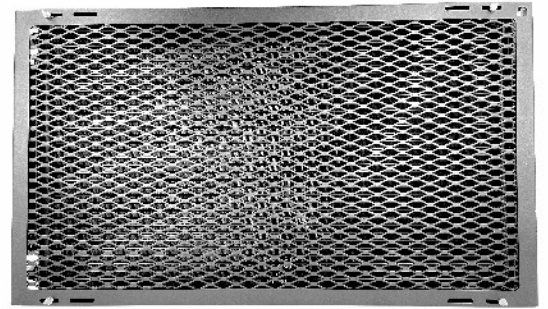
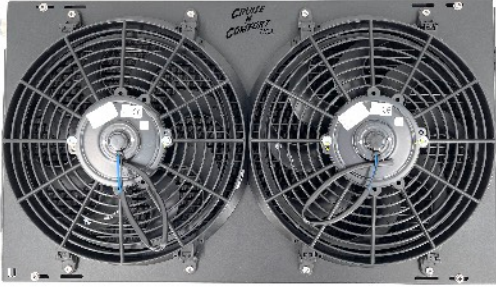

Optional Rock Guard Shown

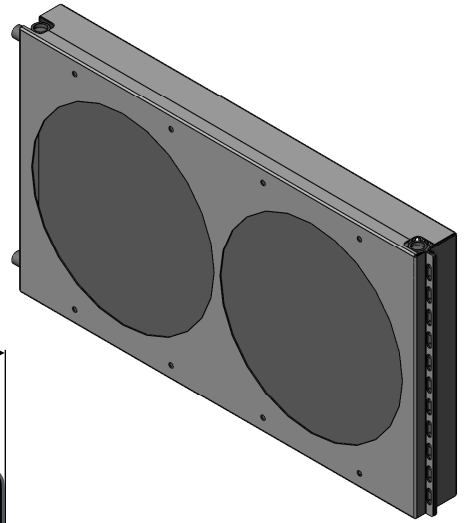
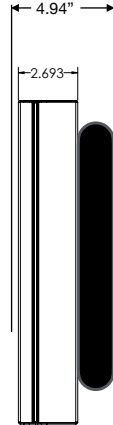
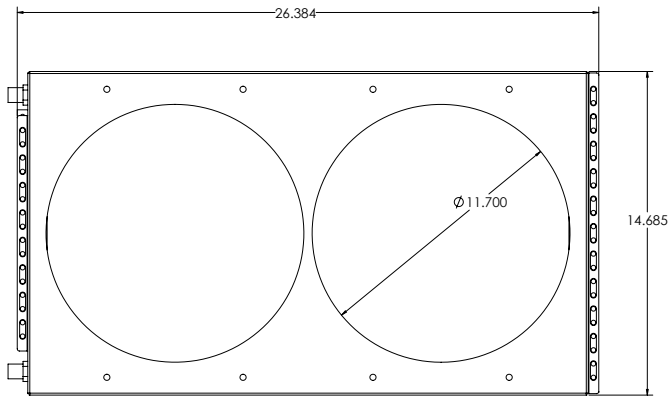
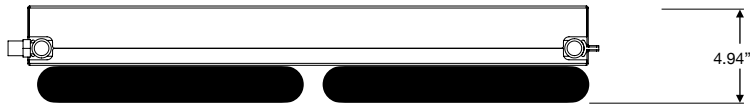

WEIGHT:  
DUAL FAN CONDENSER 11.7 LBS.  
DUAL FAN ROCK GUARD 2.1 LBS.



## Universal Condenser Mounting Brackets

These mounting brackets are made of heavy Stainless Steel and include all stainless hardware. These brackets are universal and give you the ability to mount the condenser under, on top, or on the back of the vehicle. The brackets are completely adjustable.

Weight: 3.1 LBS



\*optional rock guard shown



## Condenser Rock Guard:

The CNC Rock Guard is designed to help protect our condensers from rocks and debris. This option is available for all of our condensers and come installed on the condenser when purchased at the time the condenser and main unit are ordered new. If you previously purchased a condenser from us it will fit, but we will need an email from you with the size of your condenser (single fan or dual fan). The unit is flat black powder-coated aluminum and resists salt and corrosion. Available for all of our condensers.

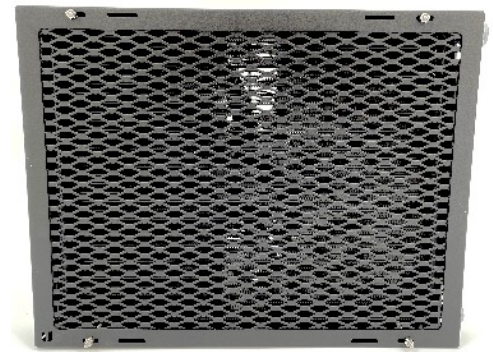

# Thermostat Options For HD Series

## DT-701 Thermostat:

The DT-701 is a basic digital thermostat that will turn the unit off at the temperature set point. A variable speed knob will need to be panel-mounted to control the blower speed on the evaporator.  
Available Colors: White



## DT-04 WiFi App Enabled Thermostat:

Our new thermostat is app enabled with a customer supplied WiFi connection and is prewired for our systems. It also has a heat function that can trigger a heating device (24 volt DC Relay required).  
Available Colors: White or Black



## Thermostat Bracket for DT-04:

The DT-04-TP is an easy solution for mounting our DT-04 thermostats. We machine these brackets, powder-coat them and assemble them with our DT-04 thermostat.  
Available Colors: White or Black

